



**Safety storage under bench cabinet UB-T-90
Model UB90.060.089.UL.2T, light grey (RAL 7035)**

Safe and approved storage of flammable hazardous substances in working areas

Function / construction:

- **Robust construction and longevity:** body made of powder-coated sheet steel
- **Easy handling with comfort:** doors stop in any position, self-closing in the event of fire
- **User-friendly:** access to all containers, 93° opening of the wing door, interior of the cabinet completely visible
- **No unauthorised use:** doors lockable with cylinder lock and locking state indicator (red/green)
- **Mobile:** castors with plinth (optionally available), easy moving of the cabinet
- **Ventilation:** integrated air ducts ready for connection (DN 50) to a technical exhaust system

Dimensions

Width (external)	893.00 mm
Depth (external)	574.00 mm
Height (external)	600.00 mm
Width (internal)	771.00 mm
Depth (internal)	452.00 mm
Height (internal)	502.00 mm

The available internal dimensions can vary depending on the interior equipment package.

Weight / Load

Weight without interior equipment	140 kg
Distributed load	313.00 kg/m ²
Maximum load	300 kg

Ventilation

Extraction air	50 DN
Minimum exhaust air quantity 10 times	1 m ³ /h
Differential pressure (10 times air change)	1 Pa

Colouring / Surface finish

Body colour code	RAL 7035
Body colour	Light grey
Body surface finish	plain
Door / Drawer colour code	RAL 7035
Door / Drawer colour	Light grey
Door / Drawer surface finish	plain

General Information

Number of doors	2
Door opening angle	93.00°
Depth with open doors	992 mm
Customs tariff number	94032080

Front view

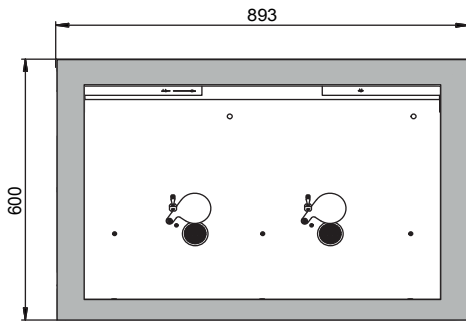

Side view

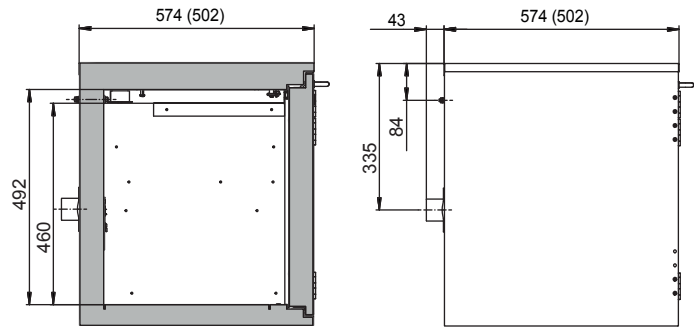

Top view

