



**Safety storage under bench cabinet UB-S-90
Model UB90.060.059.S, laboratory white (sim. RAL 9016)**

Safe and approved storage of flammable hazardous substances in working areas

Function / construction:

- **Robust construction and longevity:** body made of powder-coated sheet steel
- **User-friendly:** drawer remains open in any position, interior of drawer completely visible – access to all containers
- **Safe:** drawer fitted with earthing wire incl. clamp as standard, seal welded sump, drawers are self-closing in the event of fire
- **No unauthorised use:** drawer lockable with cylinder lock and locking state indicator (red/green)
- **Mobile:** castors with plinth (optionally available), easy moving of the cabinet
- **Ventilation:** integrated air ducts ready for connection (DN 50) to a technical exhaust system

Dimensions

Width (external)	593.00 mm
Depth (external)	574.00 mm
Height (external)	600.00 mm
Width (internal)	470.00 mm
Depth (internal)	452.00 mm
Height (internal)	502.00 mm

The available internal dimensions can vary depending on the interior equipment package.

Weight / Load

Weight without interior equipment	120 kg
Distributed load	450.00 kg/m ²
Maximum load	300 kg

Ventilation

Extraction air	50 DN
minimum exhaust air quantity 10 times	1 m ³ /h
Pressure drop inside the cabinet	1 Pa

Colouring / Surface finish

Body colour code	
Body colour	Laboratory white (sim. RAL 9016)
Body surface finish	plain
Door / Drawer colour code	
Door / Drawer colour	Laboratory white (sim. RAL 9016)
Door / Drawer surface finish	plain

General Information

Number of drawers	1
Capacity drawer	11.50 litres
Customs tariff number	94032080

Front view

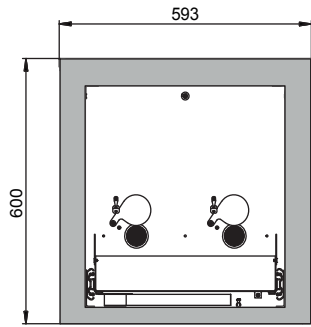

Side view

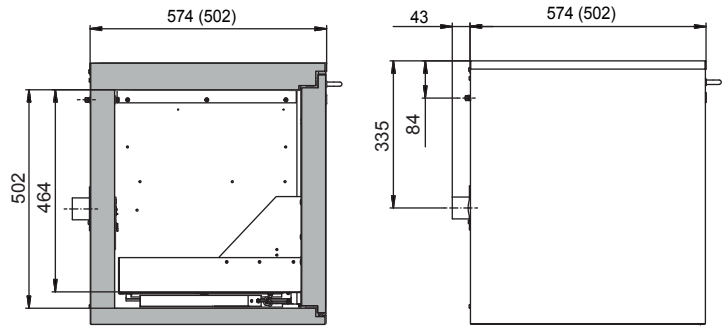

Top view

