

Dimensions

Width (external)	1102.00 mm
Depth (internal)	381.00 mm
Height (external)	601.00 mm
Width (internal)	470.00 mm
Depth (external)	502.00 mm
Height (internal)	502.00 mm

The available internal dimensions can vary depending on the interior equipment package.

Weight / Load

Weight without interior equipment	155 kg
Distributed load	275.00 kg/m ²
Maximum load	300 kg

Ventilation

Extraction air	50 DN
minimum exhaust air quantity 10 times	2 m ³ /h
Pressure drop inside the cabinet	1 Pa

Colouring / Surface finish

Body colour code	RAL 7035
Body colour	Light grey
Body surface finish	plain
Door / Drawer colour code	RAL 7035
Door / Drawer colour	Light grey
Door / Drawer surface finish	plain

General Information

Left compartment	Compartment for the storage of flammable liquids
Right compartment	Compartment for the storage of aggressive, non flammable hazardous materials
Depth with open doors	964 mm
Customs tariff number	94032080

Combi safety storage cabinet K-UB-90

Model K90.060.110.050.UB.ST, light grey (RAL 7035)

Safe and approved storage of aggressive and flammable hazardous substances in working areas

Function / construction:

- **Robust construction and longevity:** body made of powder-coated sheet steel
- **User-friendly and safe:** door and drawer remain open in any position, interior of the cabinet completely visible — access to all containers, 93° opening of the wing door
- **Safe:** drawer fitted with earthing wire incl. clamp as standard, seal welded sump, drawers are self-closing in the event of fire
- **No unauthorised use:** door and drawer lockable with cylinder lock and locking state indicator (red/green)
- **Mobile:** castors with plinth (optionally available), easy moving of the cabinet
- **Ventilation:** integrated air ducts ready for connection (DN 50) to a technical exhaust system, extraction of both compartments through one ventilation connection

Front view

Side view

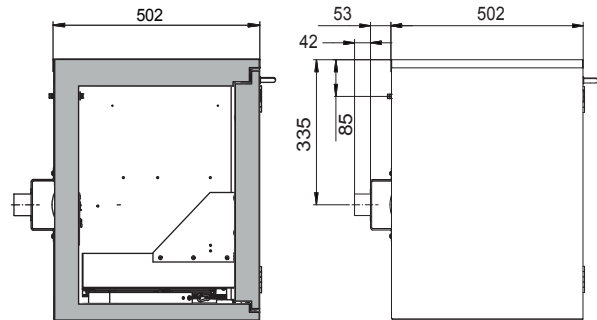
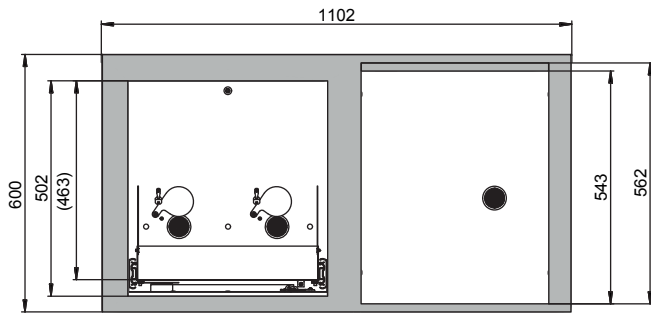

Top view

